

12x

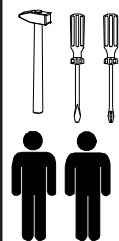

2 személyes gázrugós
ágy

1.

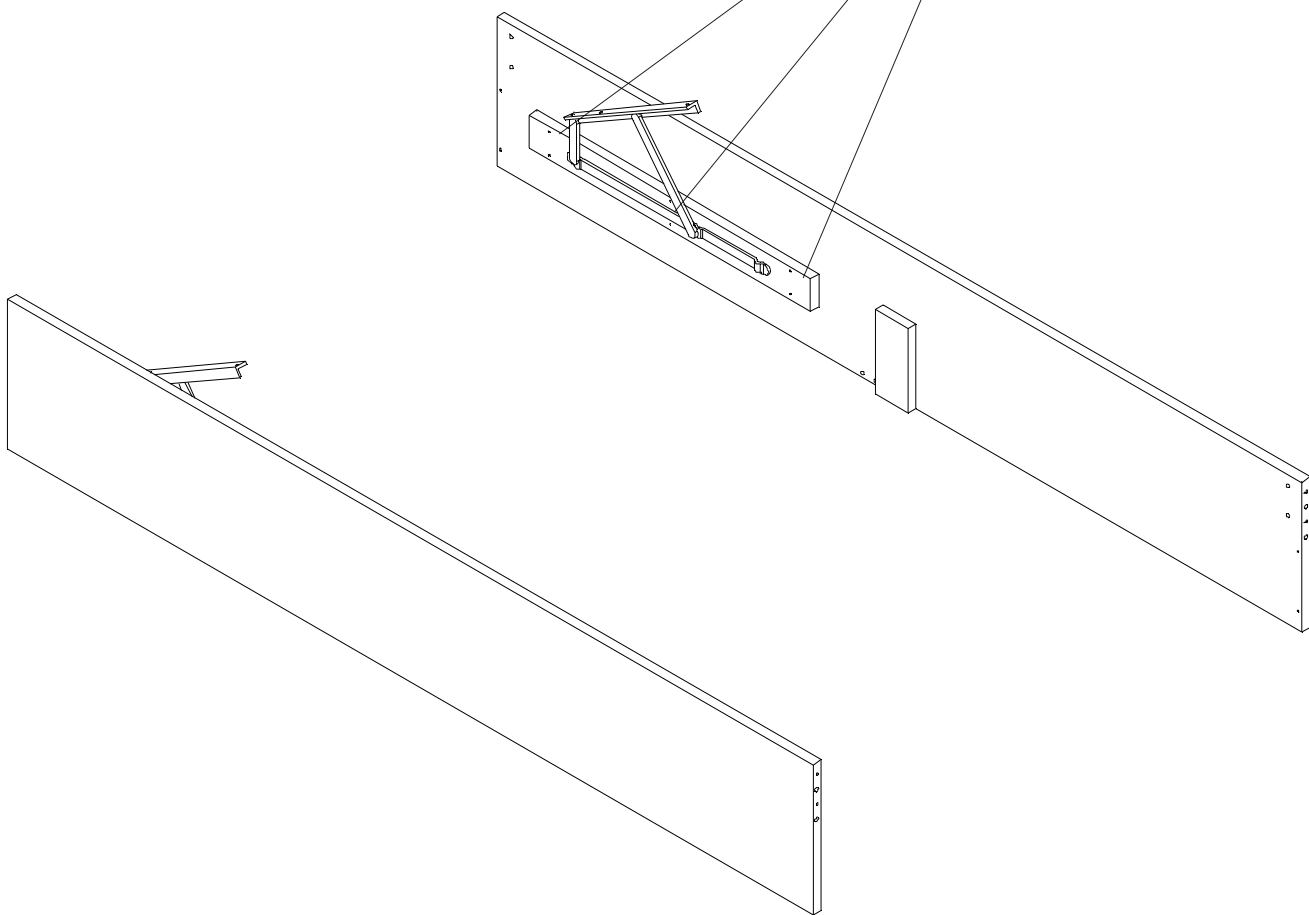
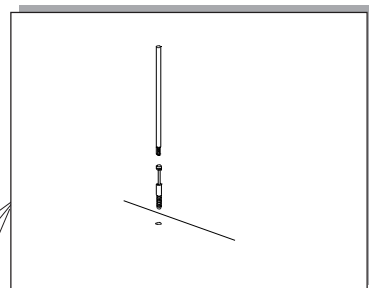

Első lépésként a gázrugó mechanikáját szerelje fel oldalanként
6-6 db facsavarral!

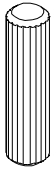

4x

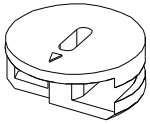

8x

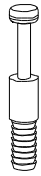

8x



60x

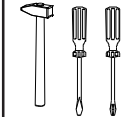

2 személyes gázrugós
ágy



2.

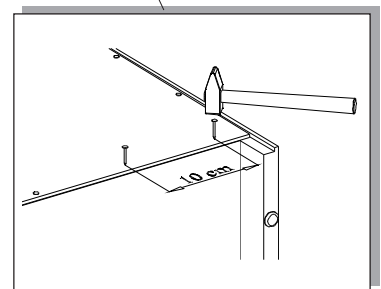
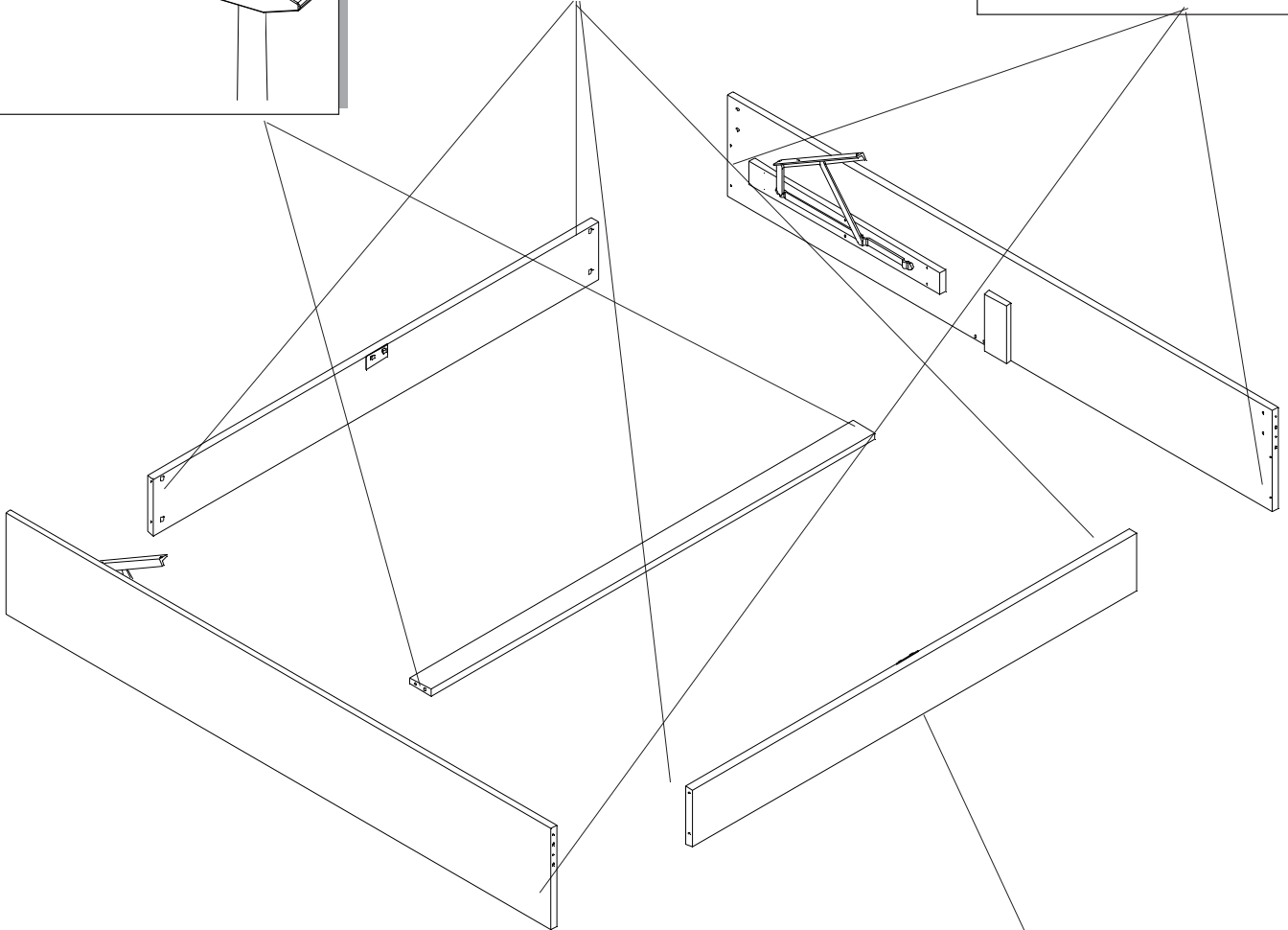
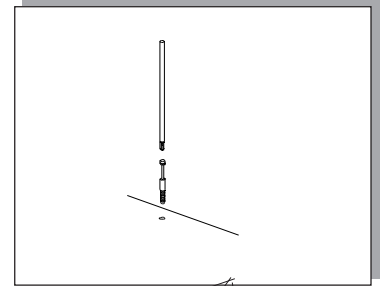
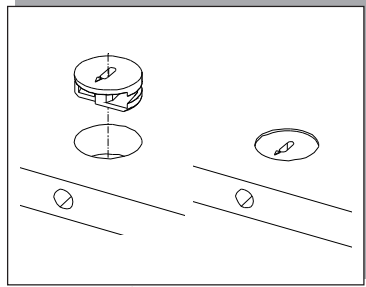
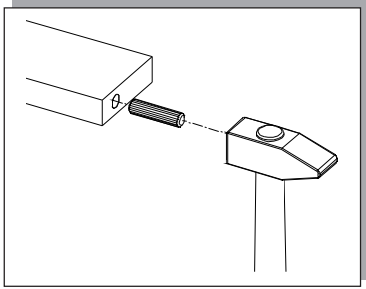

Ha végzett az oldalak összeállításával szögelje fel a
fenéklemezt!



2 személyes gázrugós
ágy



3.

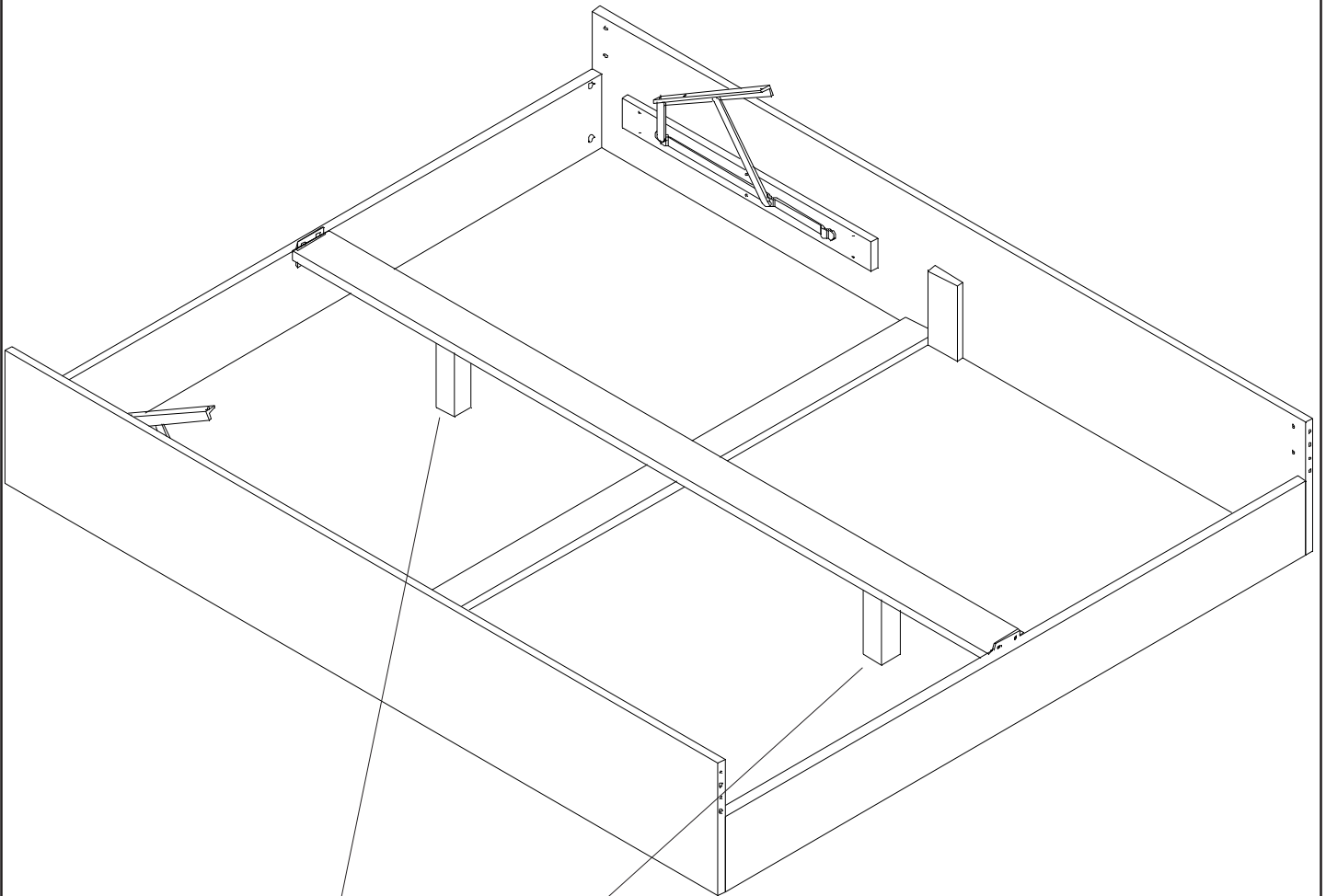

Ennél a lépésnél csavarozza be a középső lábakat a helyére,
majd a merevítővel együtt helyezze be!

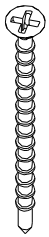

6 db

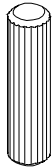

12 db



2 személyes gázrugós
ágy



4.

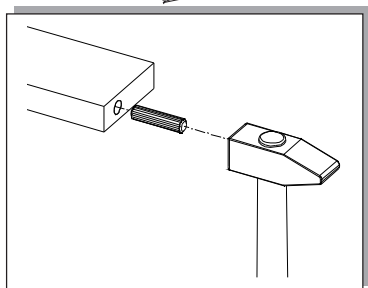
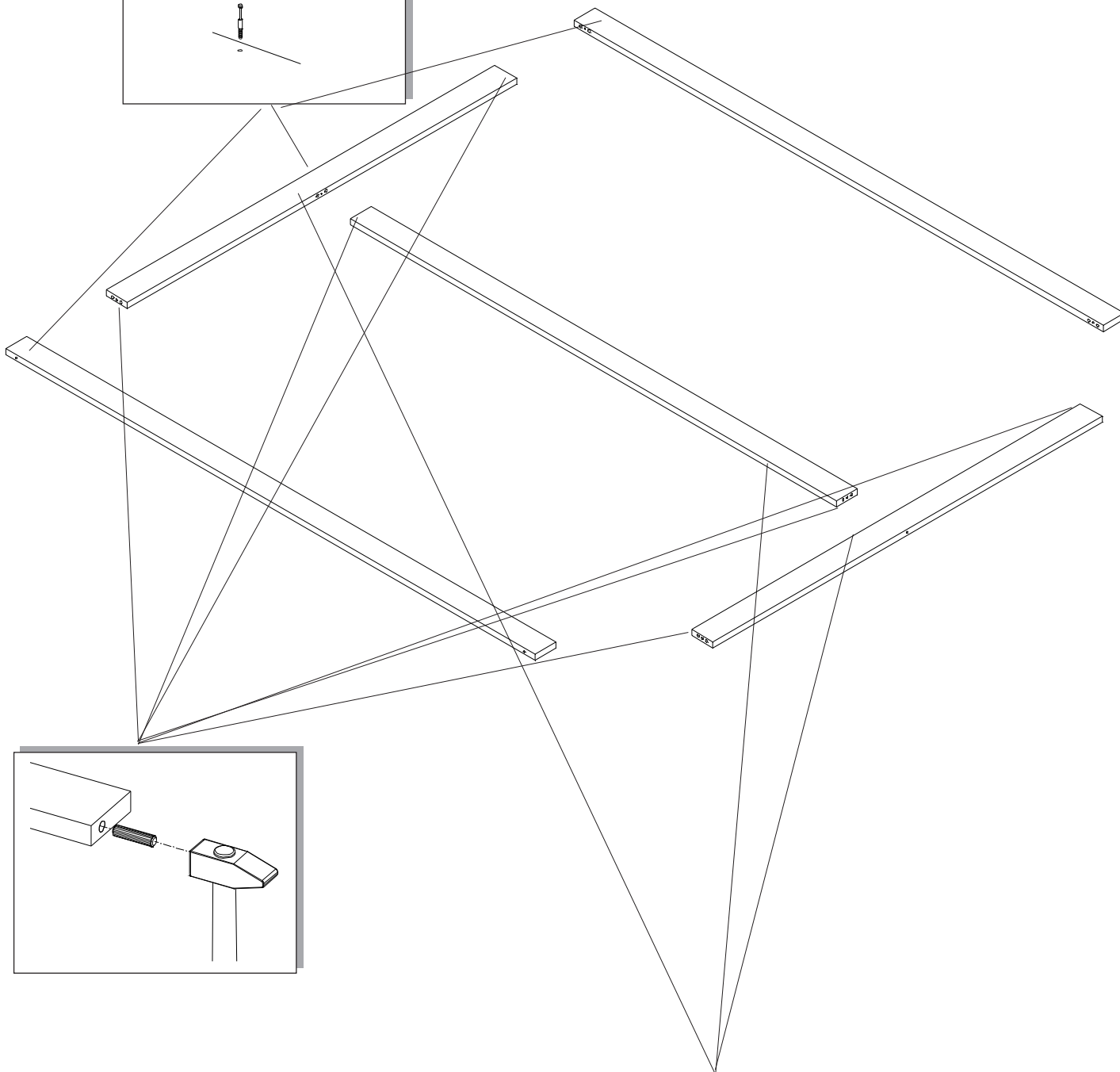
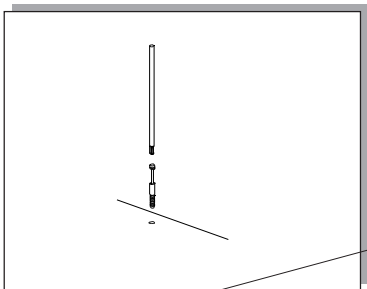

FIGYELEM! Először ezeket állítsaa össze!

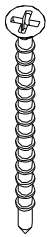

28 db

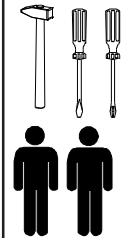

2 személyes gázrugós
ágy

5.

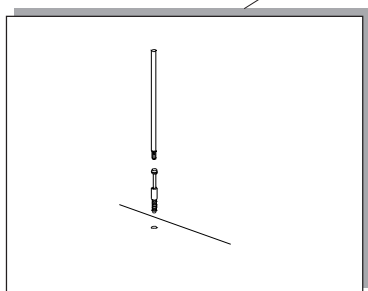
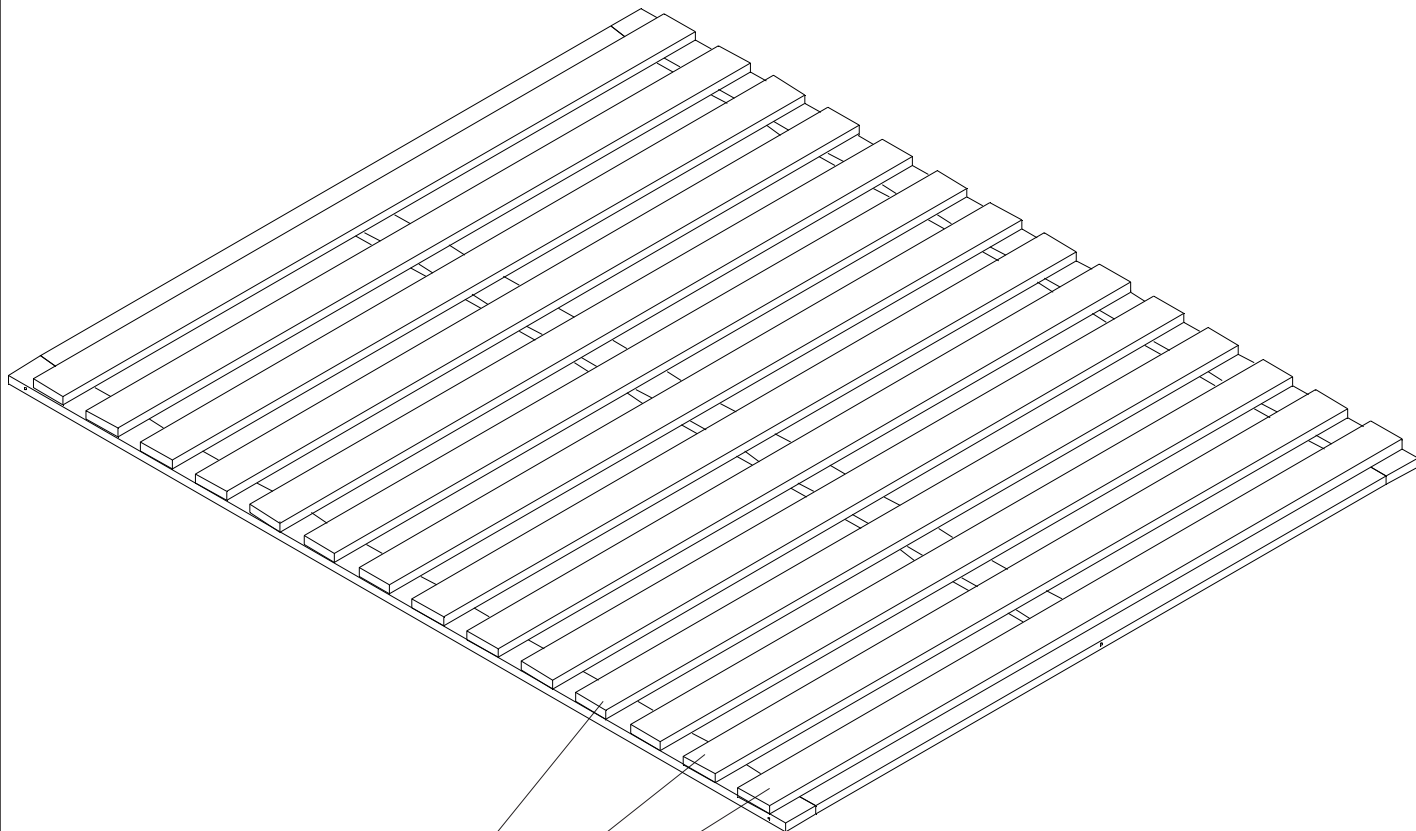

Csavarozza fel a léceket oldalanként 1-1 csavarral! Lécek
távolsága 7-8 cm!

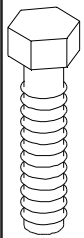

6 db



6 db



6 db

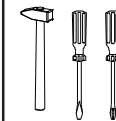

2 személyes gázrugós
ágy



6.

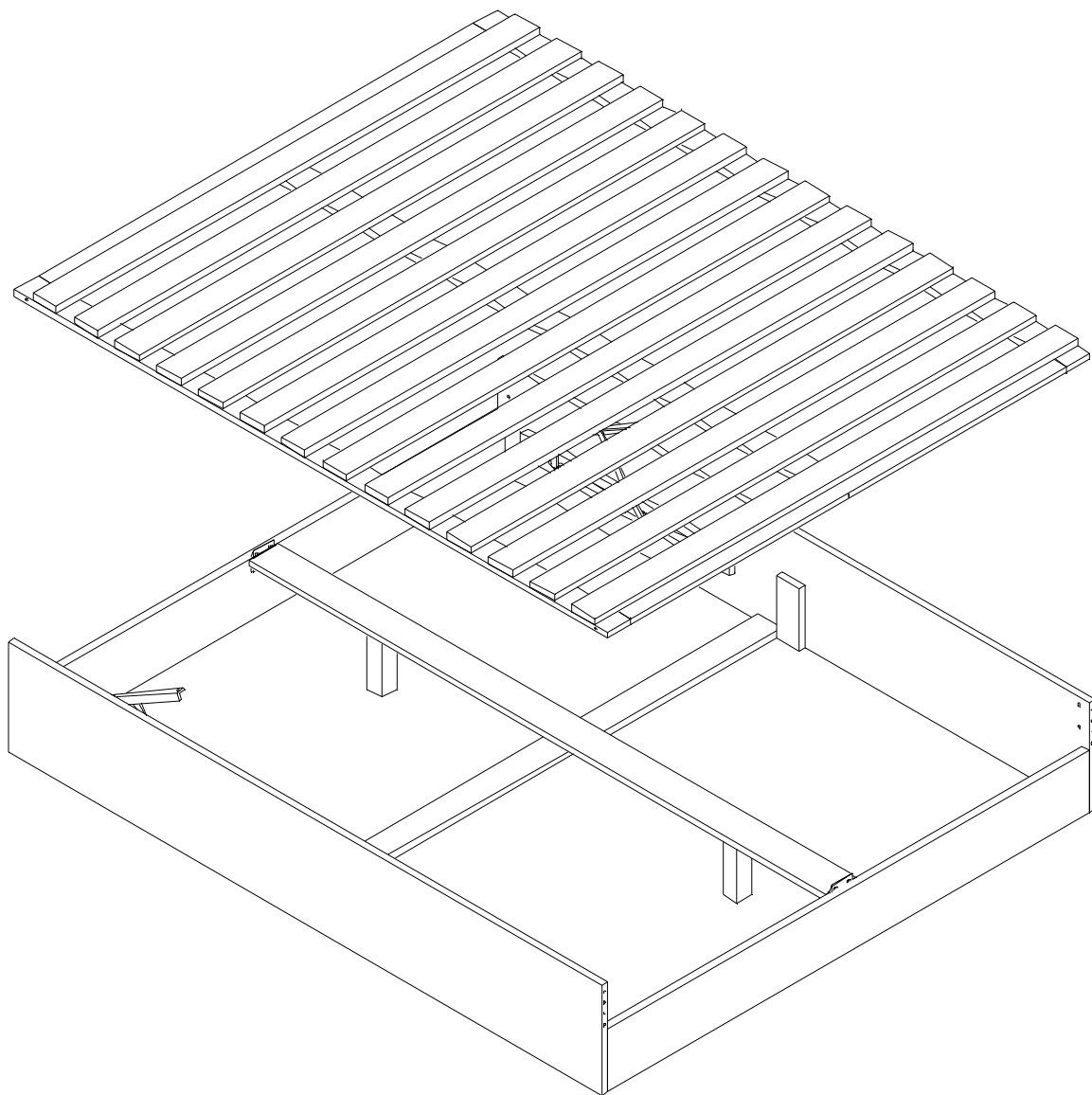

Helyezze helyére az ágyrácsot és rögzítse a gázrugó
mechanikájára! Oldalanként 3-3 metrikus csavarral és
anyával! Ha végzett csavarozza fel a gázrugót a helyére!

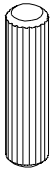

12x



8x



6x



2x



2 személyes gázrugós
ágy



7.

