

12x

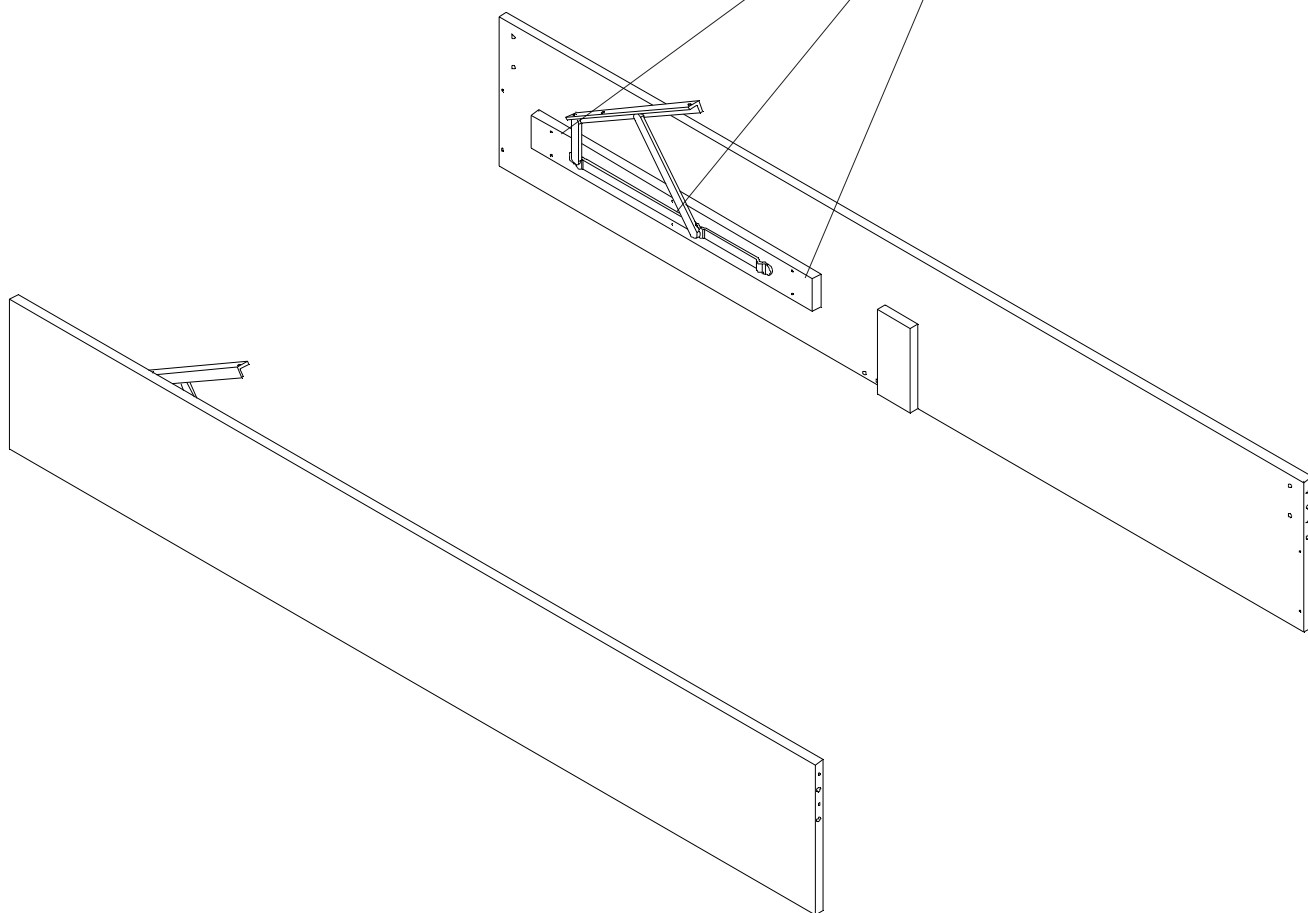

Gázrugós ágy

1.

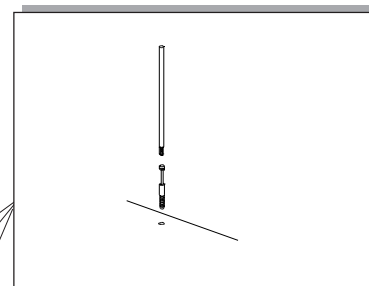

Első lépésként a gázrugó mechanikáját szerelje fel oldalanként
6-6 db facsavarral!

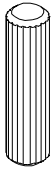

4x

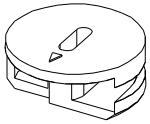

8x

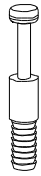

8x



40x

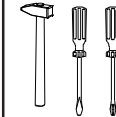

Gázrugós ágy



2.

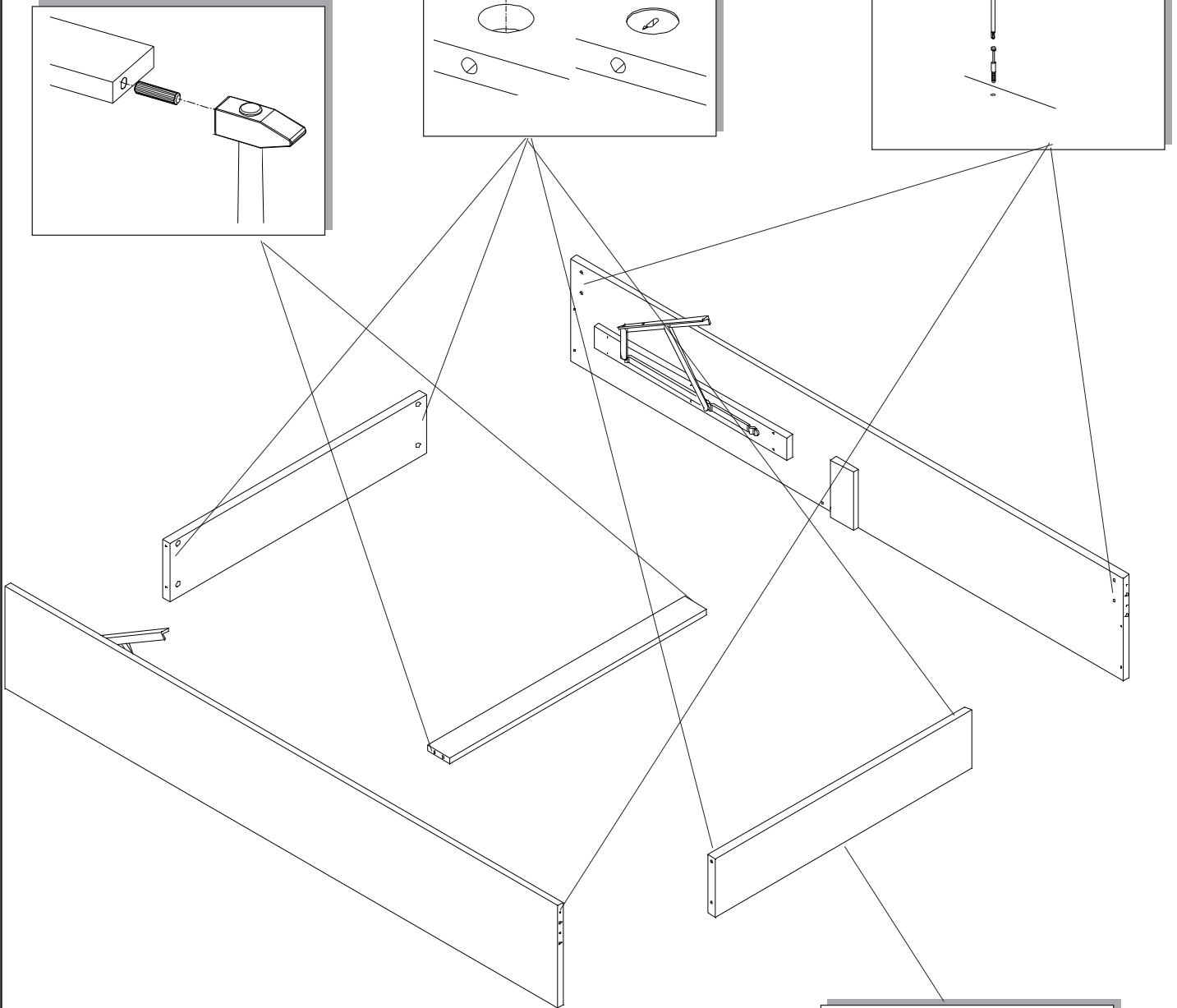
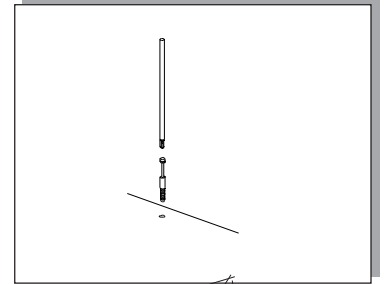
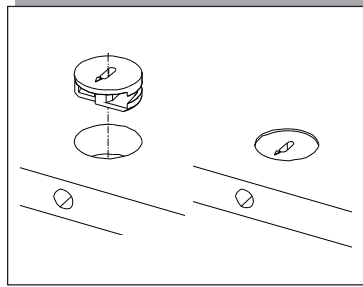
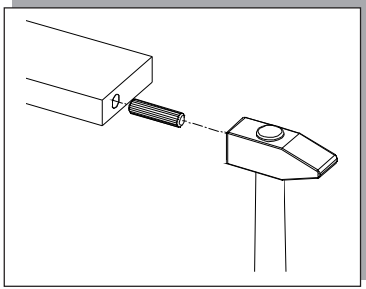

Ha végezt az oldalak összeállításával szögelje fel a fenéklemezt!

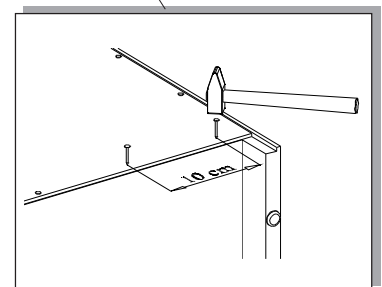

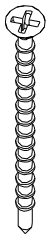

4 db

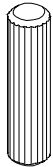

8 db

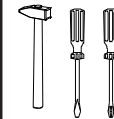

Gázrugós ágy

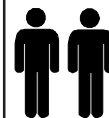

3.

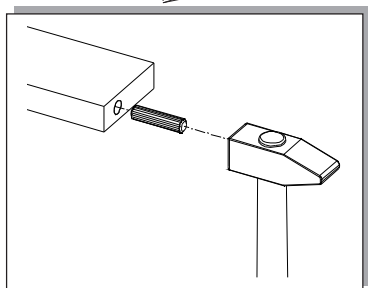
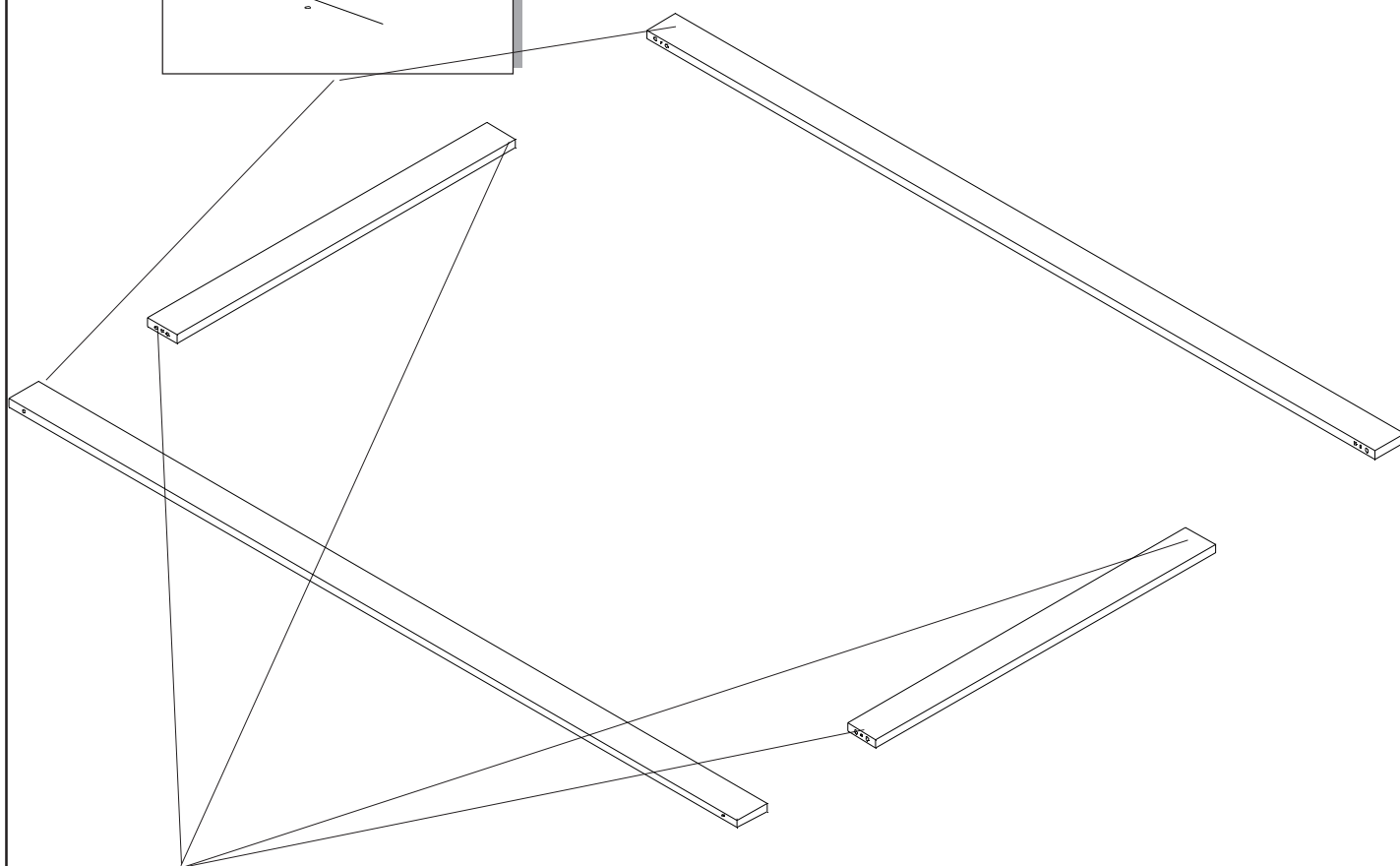
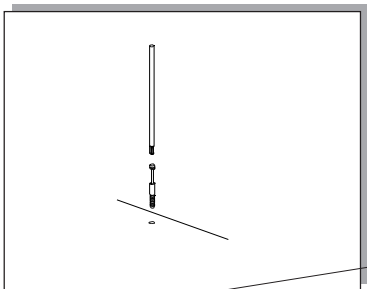

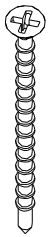

28 db

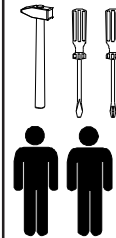

Gázrugós ágy

4.

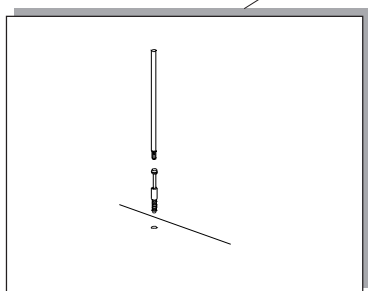
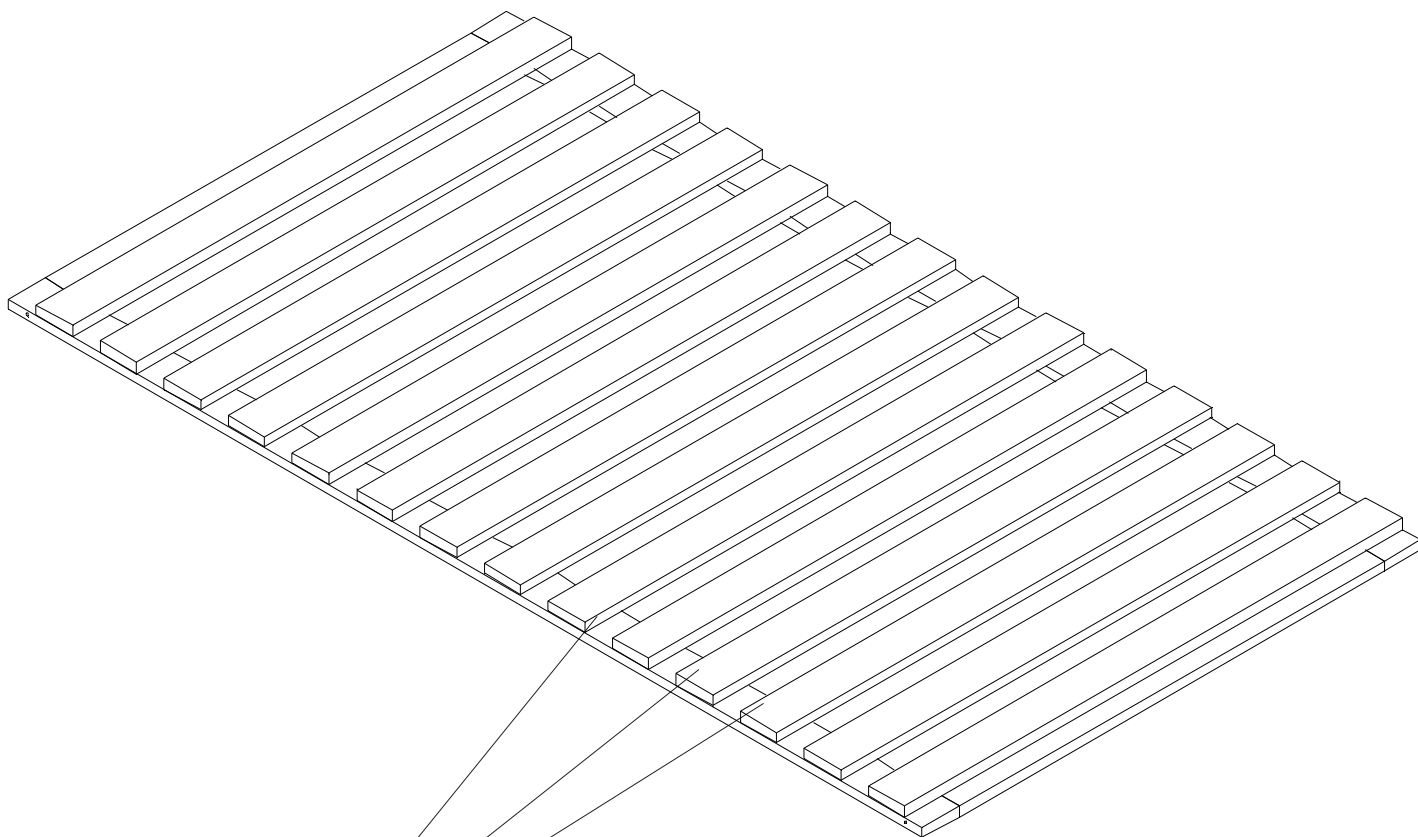

Csavarozza fel a léceket oldalanként 1-1 csavarral! Lécek távolsága 7-8 cm!

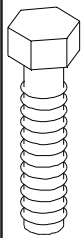

6 db



6 db



6 db



Gázrugós ágy

5.

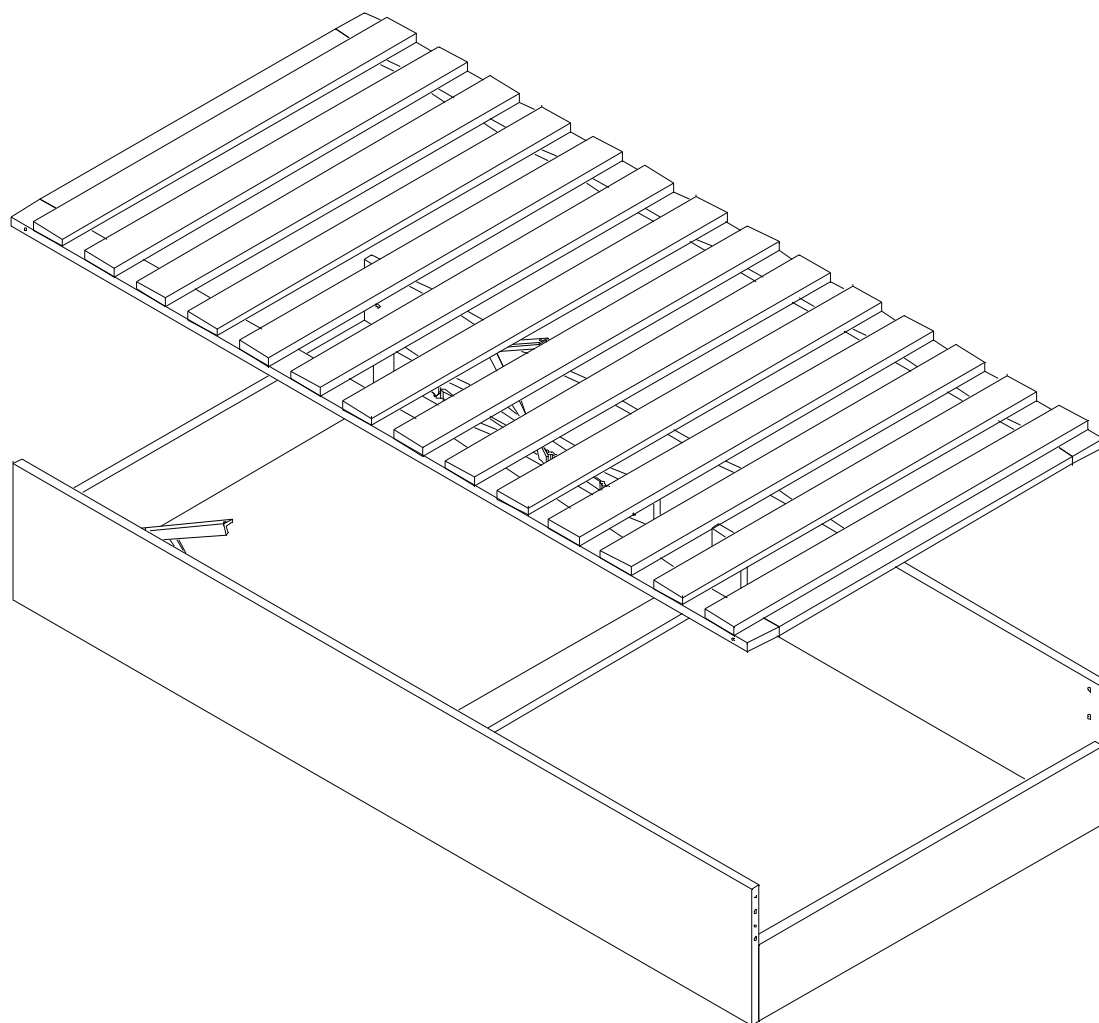

Helyezze helyére az ágyrácsot és rögzítse a gázrugó mechanikájára! Oldalanként 3-3 metrikus csavarral és anyával! Ha végzett csavarozza fel a gázrugót a helyére!

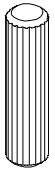

12x



8x



8x

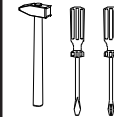

Gázrugós ágy

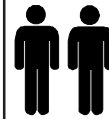

6.

