

16x

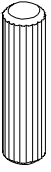

12x

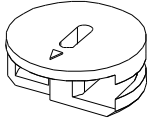

6x

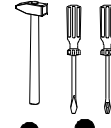
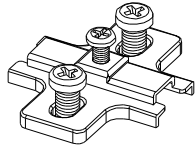

2 ajtós akasztós  
classic szekrény



Kód.: CLA  
221

Súly: 50 kg

1.

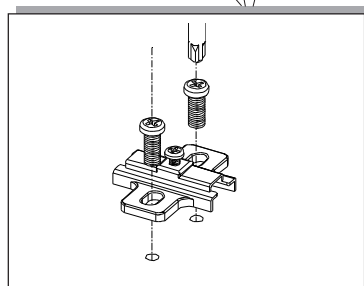
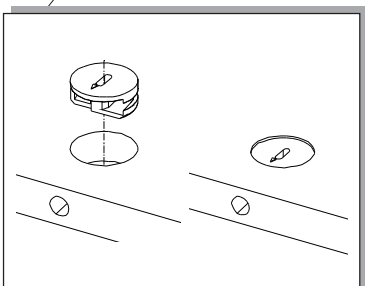
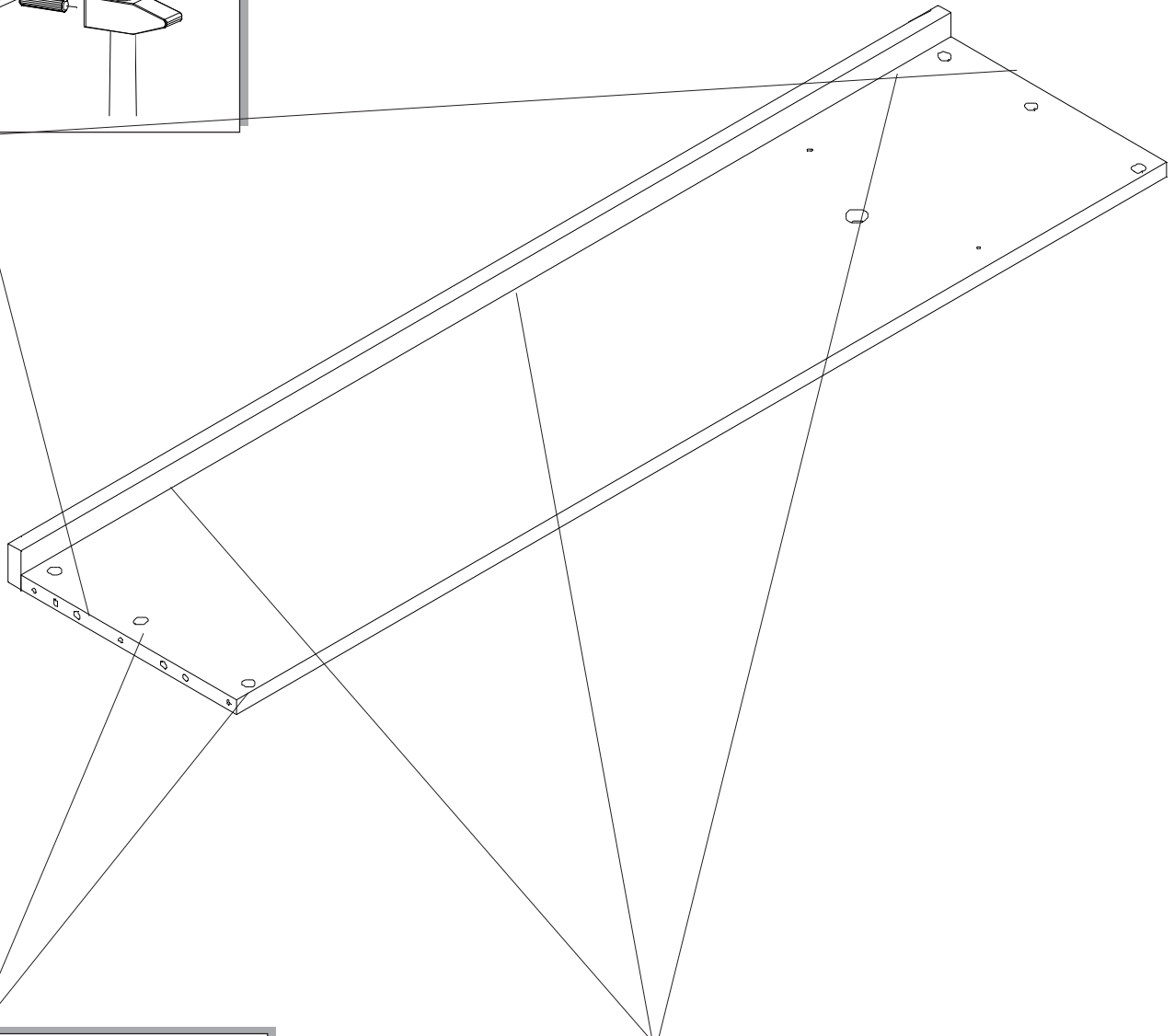
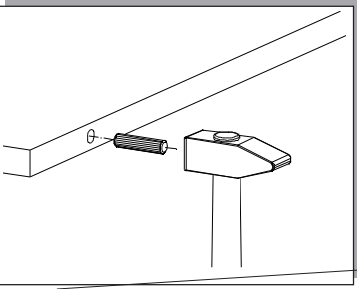

12x

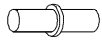
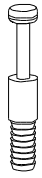

6x

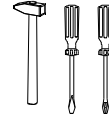

2 ajtós akasztós  
classic szekrény



Kód.: CLA  
221

Súly: 50 kg

2.

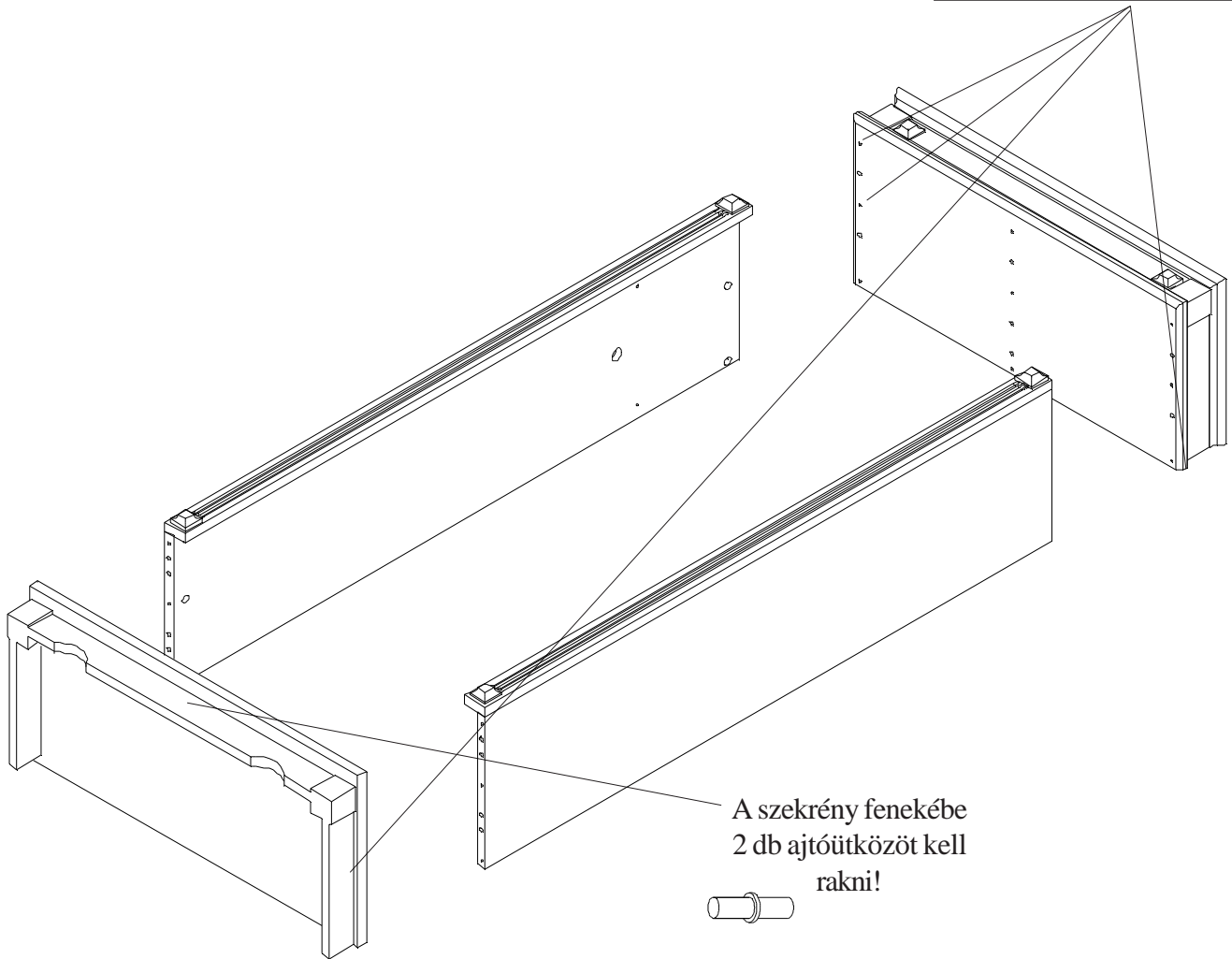
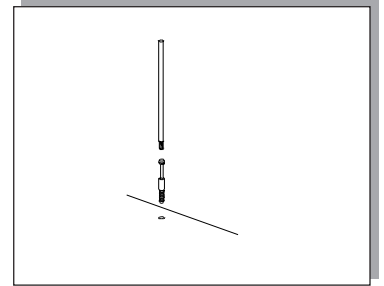

A szekrény fenekébe  
2 db ajtóütközöt kell  
rakni!



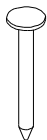

60x

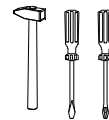

2 ajtós akasztós  
classic szekrény



Kód.: CLA  
221

Súly: 50 kg

3.

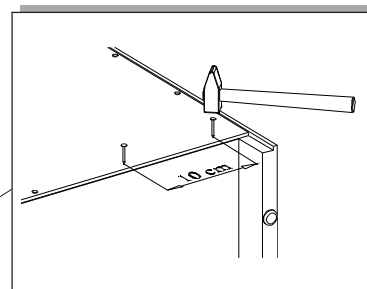
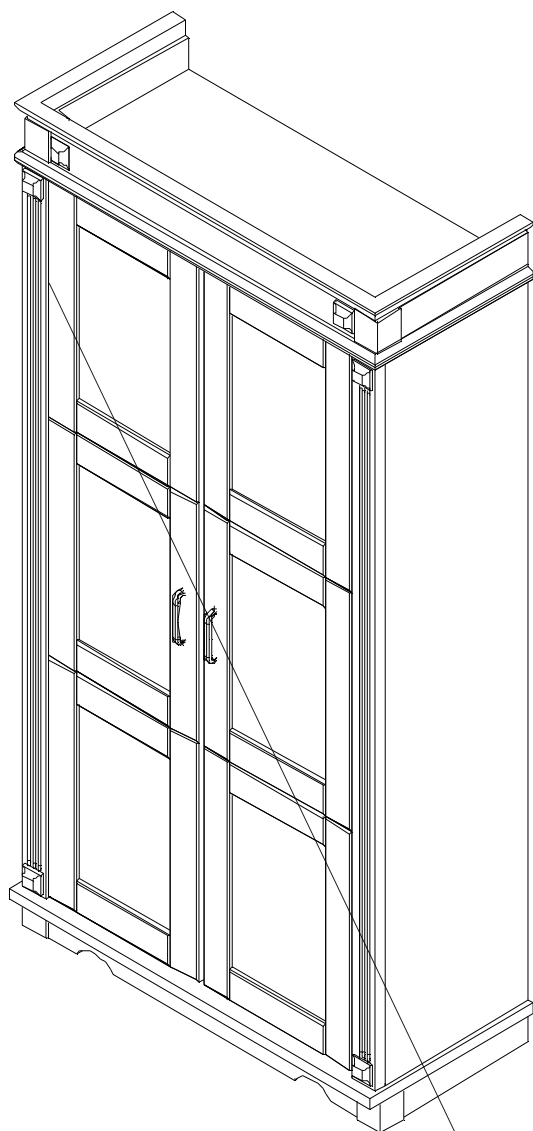

A hátfalat az ajtó és fiók behelyezése előtt  
szegezze fel!

